

Surface Mount Schottky Rectifier

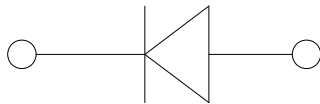

Features

- Low profile package
- Ideal for automated placement
- Guardring for overvoltage protection
- Low power losses, high efficiency
- High forward surge capability
- Meets MSL level 1, per J-STD-020, LF maximum peak of 260 °C

Typical Applications

For use in low voltage high frequency inverters, freewheeling, DC/DC converters, and polarity protection applications.

Mechanical Data

- **Package:** SOD-323HT
Molding compound meets UL 94 V-0 flammability rating, RoHS-compliant, halogen-free
- **Terminals:** Tin plated leads, solderable per J-STD-002 and JESD22-B102
- **Polarity:** Cathode line denotes the cathode end

■ Maximum Ratings (T_j=25°C Unless otherwise specified)

PARAMETER	SYMBOL	UNIT	FM22T
Device marking code			22T
Repetitive peak reverse voltage	VRRM	V	20
Average rectified output current @60Hz sine wave, Resistance load, T _c (FIG.1)	I _O	A	2.0
Surge(non-repetitive)forward current @ 60Hz half-sine wave, 1 cycle, T _j =25°C	IFSM	A	30
Forward Surge Current (Non-repetitive) @1ms, square wave, 1 cycle, T _j =25°C			60
Current squared time @1ms≤t≤8.3ms T _j =25°C, Rating of per diode	I ² t	A ² S	3.74
Typical junction capacitance @Measured at 1MHz and Applied Reverse Voltage of 4.0 V.D.C	C _j	pF	72
Storage temperature	T _{stg}	°C	-55 ~+125
Junction temperature	T _j	°C	-55 ~+125



FM22T

■Electrical Characteristics (T_j=25°C Unless otherwise specified)

PARAMETER	SYMBOL	UNIT	TEST CONDITIONS	Min	Typ	Max
Peak Forward Voltage	V _{FM}	V	I _{FM} =2.0A T _j =25°C	-	0.47	0.55
			I _{FM} =2.0A T _j =100°C	-	-	0.50
Maximum DC reverse current at rated DC blocking voltage per diode	I _{RRM1}	mA	V _{RM} =V _{RRM} T _j =25°C	-	-	0.2
	I _{RRM2}		V _{RM} =V _{RRM} T _j =100°C	-	-	10

■Thermal Characteristics (T_j=25°C Unless otherwise specified)

PARAMETER	SYMBOL	UNIT	FM22T
Thermal Resistance	R _{θJ-A}	°C/W	260 ¹⁾
	R _{θJ-L}		42 ¹⁾

Note:
(1) Thermal resistance between junction and ambient and between junction and lead mounted on P.C.B with 3mm*3mm copper pad areas.

■ Characteristics(Typical)

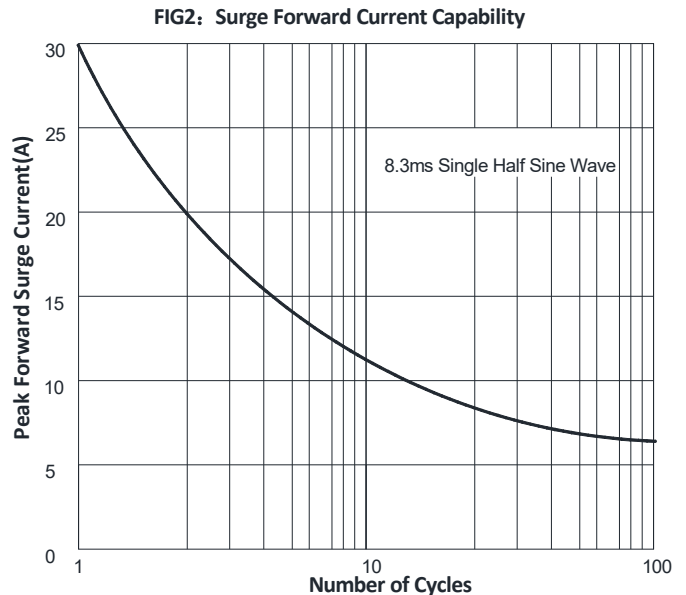
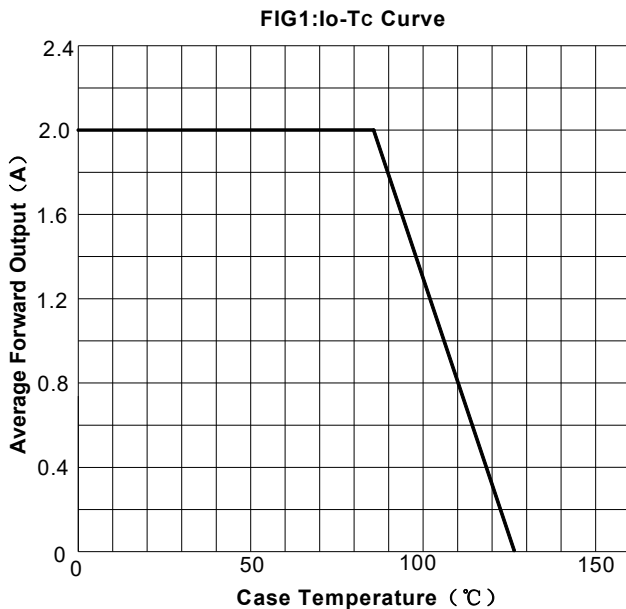



FIG.3: Forward Voltage

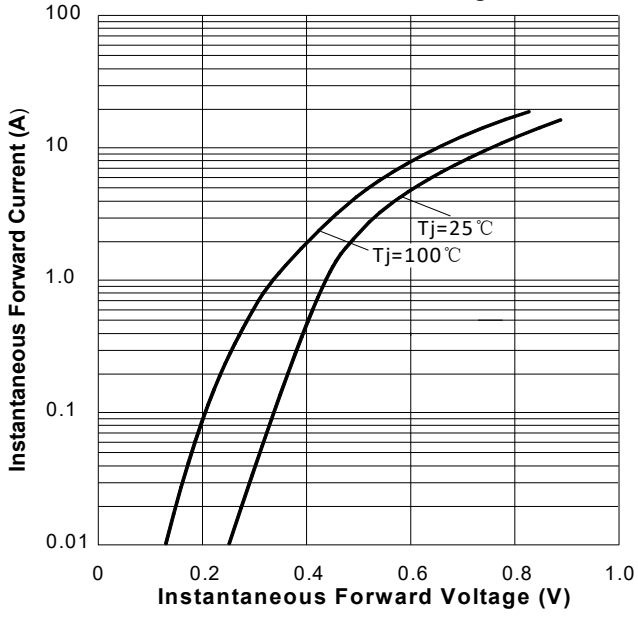
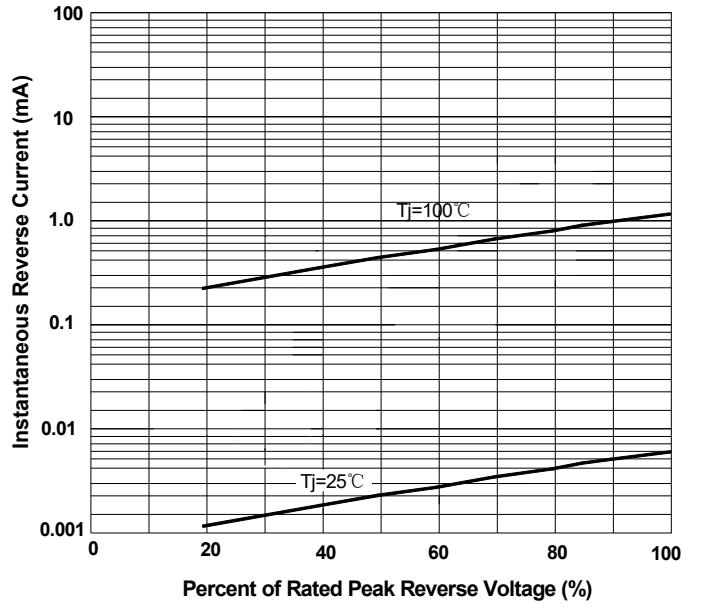
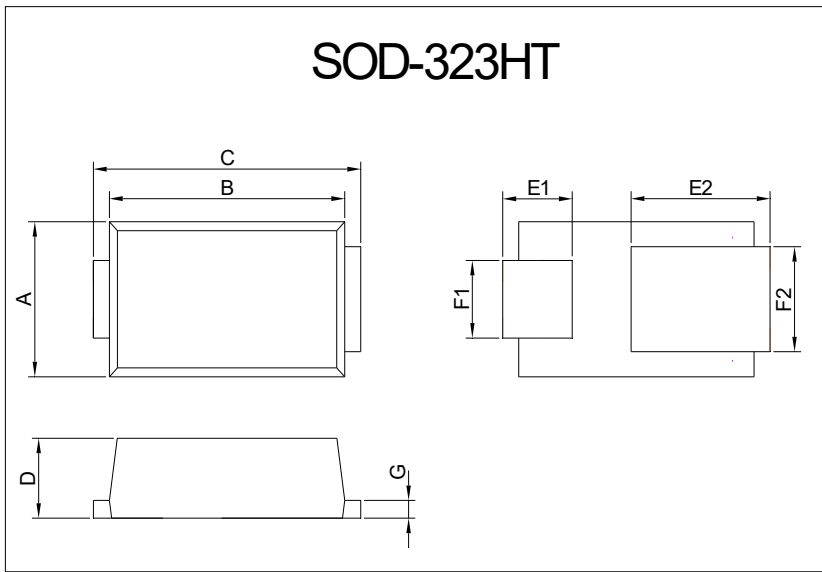

FIG.4: Instantaneous Reverse Characteristics





■ Outline Dimensions



SOD-323HT		
Dim	Min	Max
A	1.20	1.40
B	2.10	2.30
C	2.30	2.70
D	0.63	0.73
E1	0.55	0.75
E2	1.10	1.50
F1	0.55	0.75
F2	0.78	0.98
G	0.12	0.27

■ Suggested pad layout

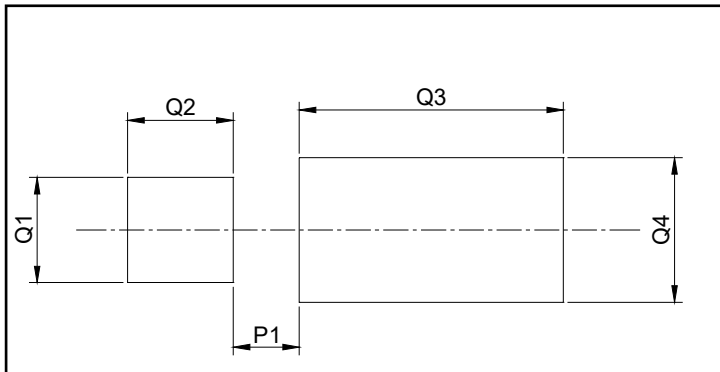

SOD-323HT	
Dim	Millimeters
P1	0.5
Q1	0.8
Q2	0.8
Q3	2
Q4	1.1



Disclaimer

The information presented in this document is for reference only. Yangzhou Yangjie Electronic Technology Co., Ltd. reserves the right to make changes without notice for the specification of the products displayed herein to improve reliability, function or design or otherwise.

The product listed herein is designed to be used with ordinary electronic equipment or devices, and not designed to be used with equipment or devices which require high level of reliability and the malfunction of which would directly endanger human life (such as medical instruments, transportation equipment, aerospace machinery, nuclear-reactor controllers, fuel controllers and other safety devices), Yangjie or anyone on its behalf, assumes no responsibility or liability for any damages resulting from such improper use of sale.

This publication supersedes & replaces all information previously supplied. For additional information, please visit our website [http:// www.21yangjie.com](http://www.21yangjie.com) , or consult your nearest Yangjie's sales office for further assistance.